

8 | 7 | 6 | 5 | 4 | 3 | 2 | 1

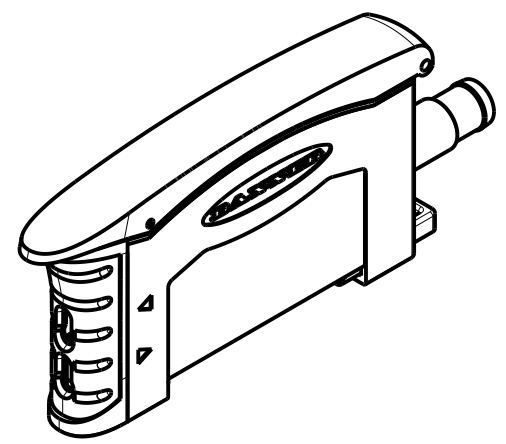

ISOMETRIC VIEW
SCALE 1:1

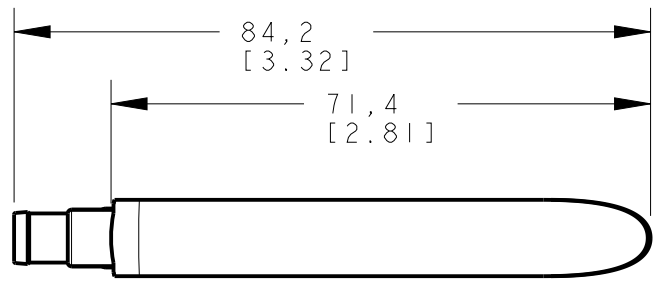
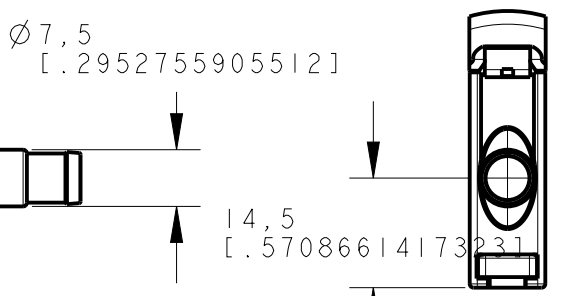
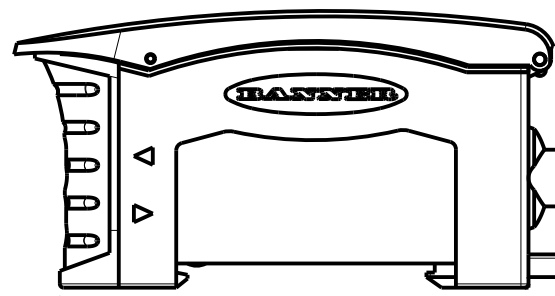
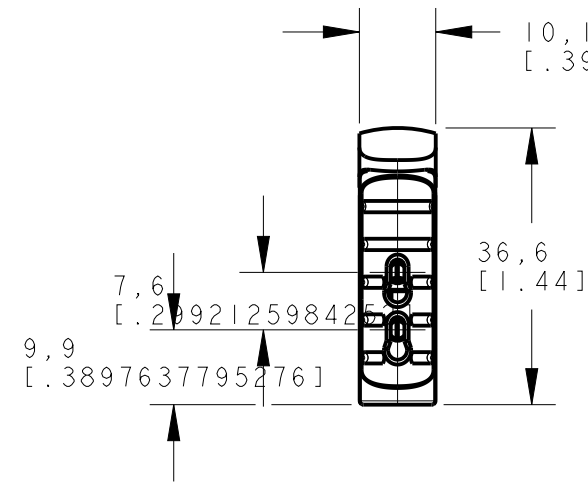
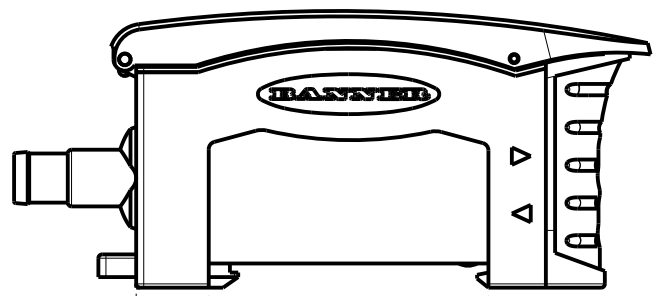

This drawing is the property of BANNER ENGINEERING CORP. Any use or reproduction, in any form, without prior written permission of Banner is prohibited. © 2015 Banner Engineering Corp.

BANNER BANNER ENGINEERING CORP.
www.bannerengineering.com

TITLE
**D10AF OD
WEB CAD DRAWINGS 2D/3D**

THIRD ANGLE PROJECTION

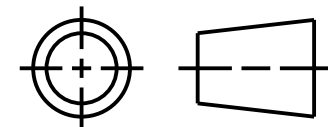

SIZE B	DRAWING NO. 156685	REV.
-----------	------------------------------	------

SCALE 1:1	SHEET 1 OF 1
--------------	-----------------

NOTES:
1. ALL DIMENSIONS ARE MILLIMETERS [INCHES] UNLESS OTHERWISE NOTED.
2. REFER TO "www.bannerengineering.com" FOR ADDITIONAL DATA AND SPECIFICATIONS.

8 | 7 | 6 | 5 | 4 | 3 | 2 | 1 CREO